

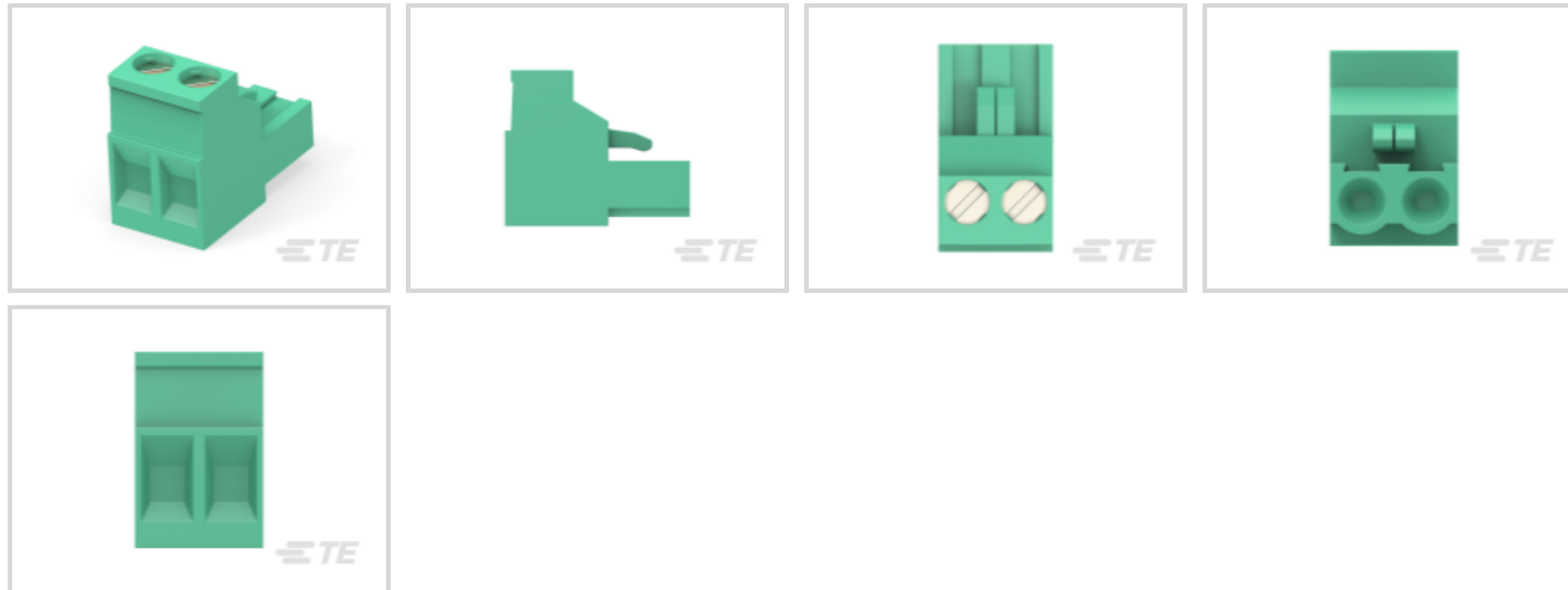

Connectors > Terminal Blocks & Strips > PCB Terminal Blocks

Terminal Block Connector Type: **Plug**Connector System: **Wire-to-Board**Number of Positions: **2**Centerline (Pitch): **5.08 mm [.2 in]**Number of Rows: **1**

Features

Product Type Features

Wire Protection	With
Block Type	Stacking Plug
Terminal Block Connector Type	Plug
Connector System	Wire-to-Board
Connector & Contact Terminates To	Wire & Cable

Configuration Features

Stacked Levels	With
Stacking Configuration	Side Stackable
Number of Positions	2
Number of Rows	1
Wire Entry Angle	Side

Electrical Characteristics

Current Rating (Max)	15 A
Voltage Rating	300 VAC



Body Features

Interlock	Without
-----------	---------

Contact Features

Contact Mating Area Plating Material	Tin
Contact Mount	Through Hole
Contact Base Material	Phosphor Bronze
Contact Current Rating (Max)	15 A

Mechanical Attachment

Mating Angle	180°
Screwless Terminal Block	No
Mounting Angle	Right Angle
Screw Size	M3
Screw Plating Material	Nickel
Screw Material	Brass
Screw Flange	Without

Housing Features

Housing Color	Green
Housing Material	PA 66
Centerline (Pitch)	5.08 mm [.2 in]

Dimensions

Wire Size	.05 – 3 mm ²
-----------	-------------------------

Usage Conditions

Operating Temperature Range	-40 – 105 °C [-40 – 221 °F]
-----------------------------	-----------------------------

Operation/Application

Circuit Application	Power & Signal
---------------------	----------------

Packaging Features

Packaging Quantity	300
--------------------	-----

Product Compliance

For compliance documentation, visit the product page on [TE.com](https://www.te.com)>

EU RoHS Directive 2011/65/EU	Compliant with Exemptions
------------------------------	---------------------------

EU ELV Directive 2000/53/EC

Compliant with Exemptions

China RoHS 2 Directive MIIT Order No 32, 2016

Restricted Materials Above Threshold

EU REACH Regulation (EC) No. 1907/2006

Current ECHA Candidate List: JUNE 2022 (224)

Candidate List Declared Against: JUNE 2022 (224)

SVHC > Threshold:

Pb (2.02% in Component Part)

Article Safe Usage Statements:

Do not eat, drink or smoke when using this product. Wash thoroughly after handling. Recycle if possible and dispose of the article by following all applicable governmental regulations relevant to your geographic location.

Halogen Content

Low Halogen - Br, Cl, F, I < 900 ppm per homogenous material. Also BFR/CFR/PVC Free

Solder Process Capability

Not applicable for solder process capability

Product Compliance Disclaimer

This information is provided based on reasonable inquiry of our suppliers and represents our current actual knowledge based on the information they provided. This information is subject to change. The part numbers that TE has identified as EU RoHS compliant have a maximum concentration of 0.1% by weight in homogenous materials for lead, hexavalent chromium, mercury, PBB, PBDE, DBP, BBP, DEHP, DIBP, and 0.01% for cadmium, or qualify for an exemption to these limits as defined in the Annexes of Directive 2011/65/EU (RoHS2). Finished electrical and electronic equipment products will be CE marked as required by Directive 2011/65/EU. Components may not be CE marked. Additionally, the part numbers that TE has identified as EU ELV compliant have a maximum concentration of 0.1% by weight in homogenous materials for lead, hexavalent chromium, and mercury, and 0.01% for cadmium, or qualify for an exemption to these limits as defined in the Annexes of Directive 2000/53/EC (ELV). Regarding the REACH Regulation, the information TE provides on SVHC in articles for this part number is based on the latest European Chemicals Agency (ECHA) 'Guidance on requirements for substances in articles' posted at this URL: <https://echa.europa.eu/guidance-documents/guidance-on-reach>

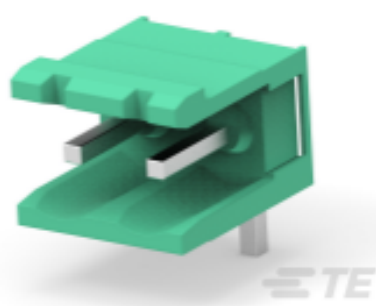
Compatible Parts

TE Part # 282814-2
TERMI-BLOK HEADER,ASSY90 2P.5

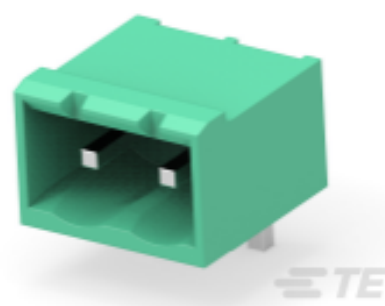

TE Part # 796638-2
2POS 5.08MM CE R/A HDR,TRM BLK

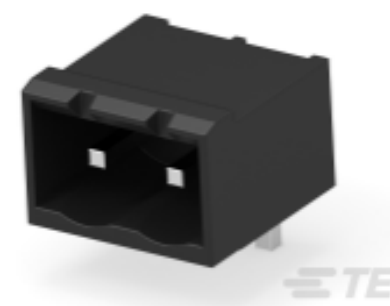

TE Part # 796639-2
2POS 5.08MM CE R/A HDR,TRM BLK

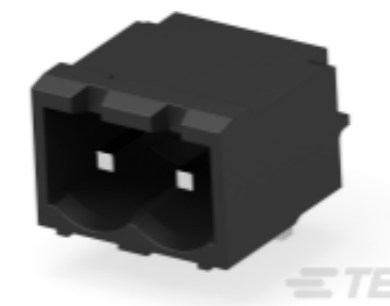

TE Part # 2342083-2
2POS HDR 90 DEG, HT,5.08MM PITCH,TL2.6MM



TE Part # 2342084-2
2POS HDR ST, HT, 5.08MM PITCH, TL 2.6MM



TE Part # 1546108-2
EUROSTYLE TB PLUG GREY STKG 2P

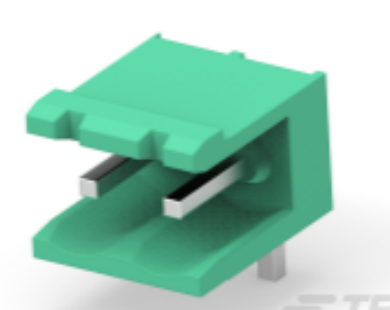

TE Part # 282815-2
TERMI-BLOK HEADER,ASSY90 2P.5



TE Part # 282824-2
TERMI-BLOK HEADER,ASSY90 2P.5

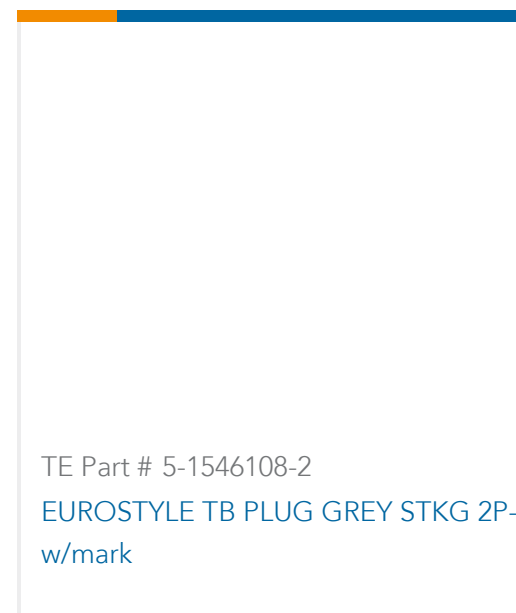
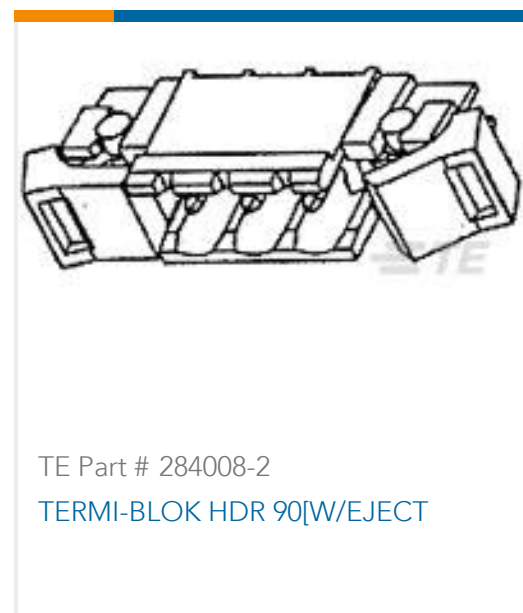

Documents

Product Drawings

[2 POS 5.08MM R/A PLUG,TRM BLK](#)

English

CAD Files

Customer View Model

[ENG_CVM_CVM_796634-2_R1.3d_igs.zip](#)

English

Customer View Model

[ENG_CVM_CVM_796634-2_R1.3d_stp.zip](#)

English

Customer View Model

[ENG_CVM_CVM_796634-2_R1.2d_dxf.zip](#)

English

3D PDF

3D

By downloading the CAD file I accept and agree to the [Terms and Conditions](#) of use.

Datasheets & Catalog Pages



[Eurostyle Terminal Blocks Focus Product Stock List](#)

English

[BUCHANAN TERMINAL BLOCKS CATALOG - EUROSTYLE TERMINAL BLOCKS](#)

English

[BUCHANAN PCB TERMINAL BLOCKS](#)

English

[1-1773458-1_EURO_STYLE_TERMINAL_BLOCKS_QRG](#)

English

[Product Specifications](#)

[Application Specification](#)

English